

DOUBLE ROBE HOOK

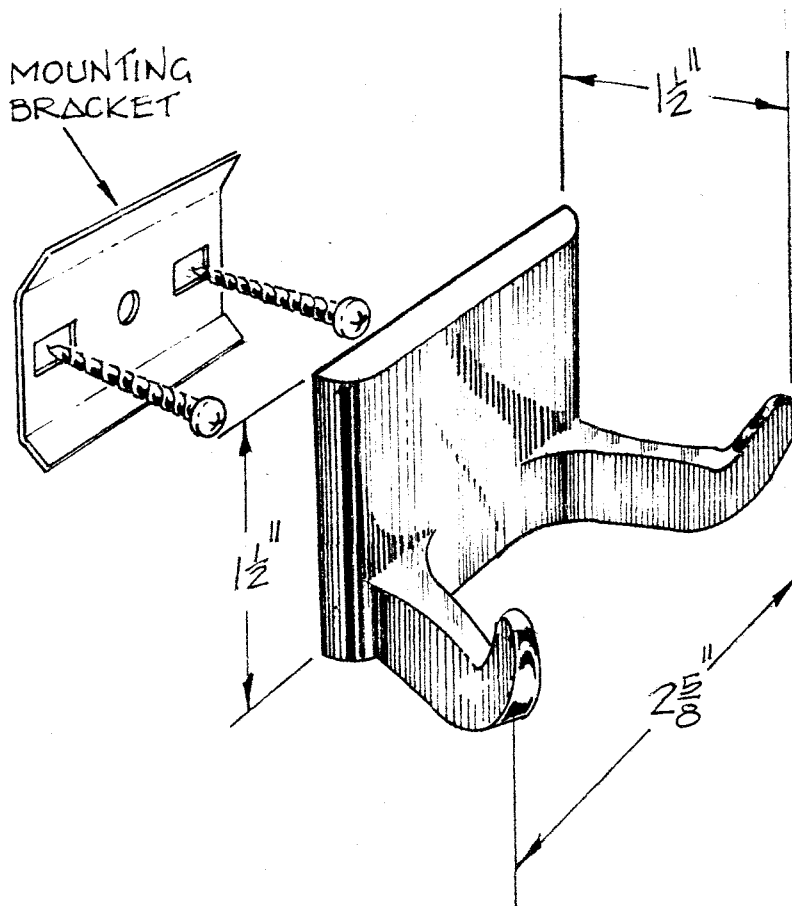

CONSTRUCTION:

Double robe hook is chrome plated zinc die-cast (zamak) designed for concealed screw mounting.

INSTALLATION:

Secure metal wall plate to stud or solid backing with mounting screws provided. Slip double robe hook over wall plate and tighten set screw until secure.

SPECIFICATION:

Double robe hook shall be model 753 by CWECO, Inc.